

**MOULDS AND
ACCESSORIES CATALOG**
CATÁLOGO DE MOLDES Y ACCESORIOS

Finamac»»
The Finest Automated Machines



FINAMAC.COM

+1-877-342-7458 | +1-786-408-0729

11231 NW 20TH STREET UNIT 130 MIAMI, FL 33172

 facebook.com/FinamacGlobal

 [@finamacglobal](https://instagram.com/finamacglobal)

 youtube.com/FinamacEnglish

MOLD DIMENSIONS

DIMENSIONES DE LOS MOLDES

MODELS WITH 18 CAVITIES

MODELOS CON 18 CAVIDADES

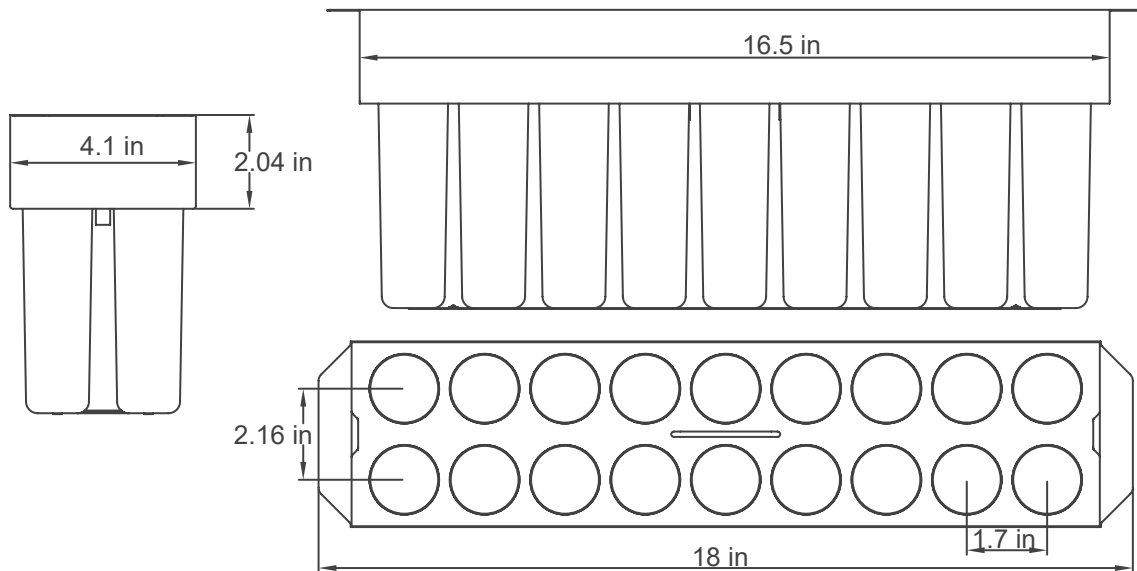

MODELS WITH 26 CAVITIES

MODELOS CON 26 CAVIDADES

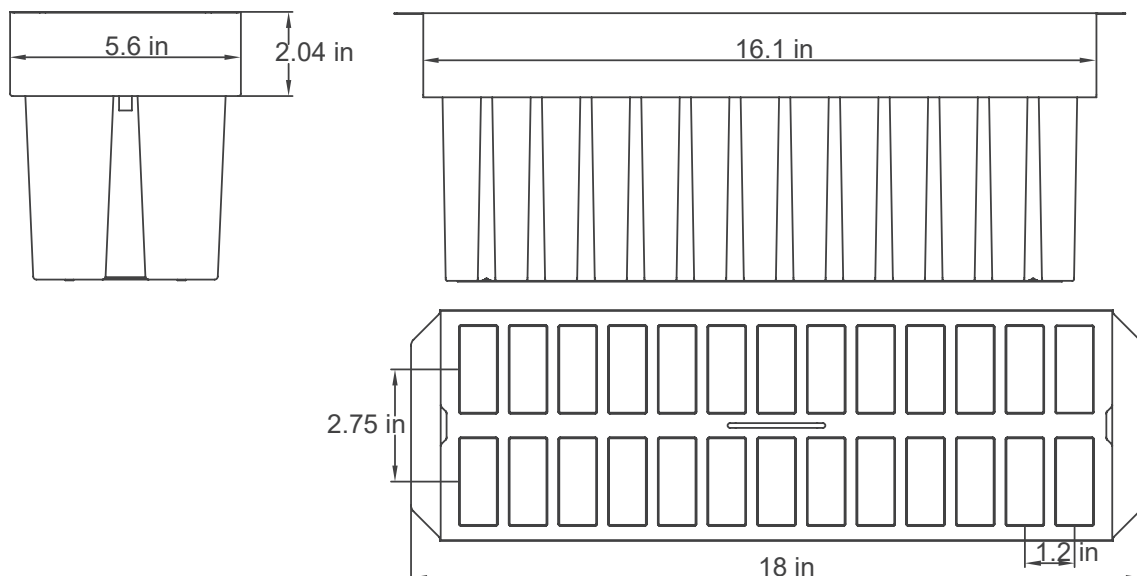

We also have online and presential courses, recipe books and consulting. Check it out on our website: finamac.com

También tenemos cursos presenciales y online, libros de recetas y consultoría. Compruébalo en nuestro sitio web: finamac.com

MOLD DIMENSIONS

DIMENSIONES DE LOS MOLDES

MODELS WITH 14 CAVITIES

MODELOS CON 14 CAVIDADES

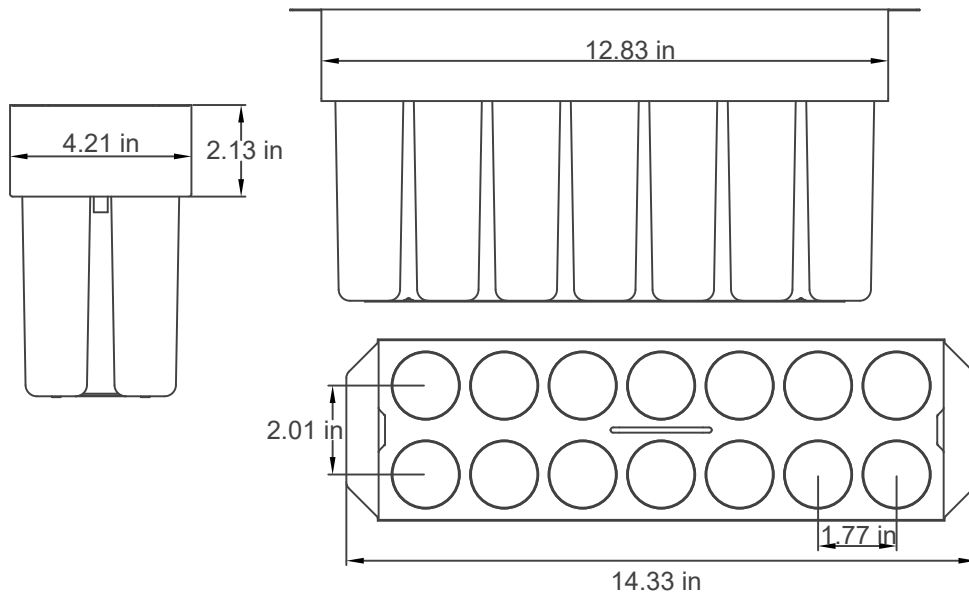

MODELS WITH 28 CAVITIES

MODELOS CON 28 CAVIDADES

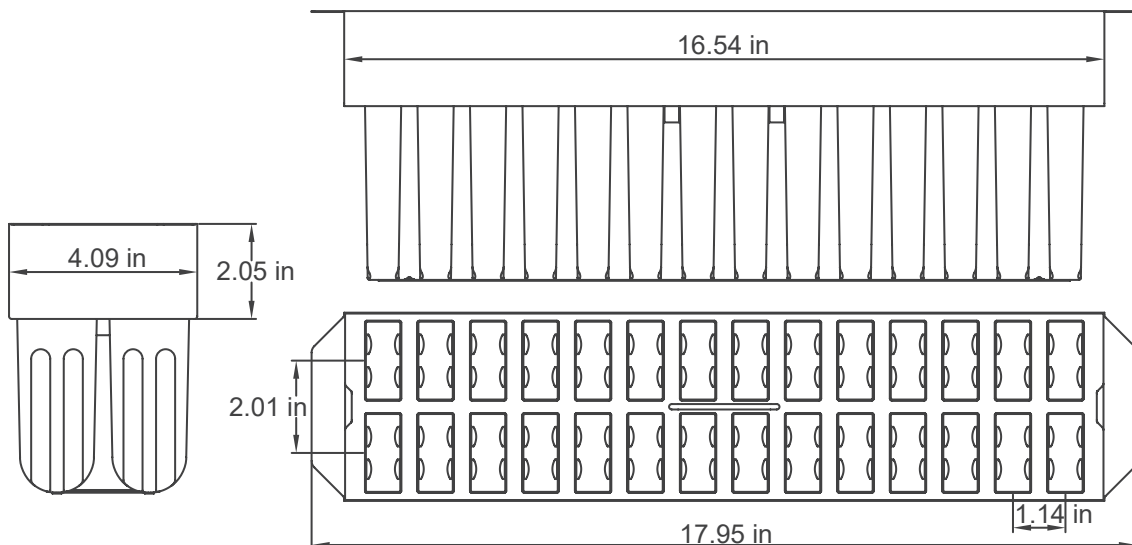

We also have online and presental courses, recipe books and consulting. Check it out on our website: finamac.com

También tenemos cursos presenciales y online, libros de recetas y consultoría. Compruébalo en nuestro sitio web: finamac.com

MODELS WITH 18 CAVITIES

MODELOS CON 18 CAVIDADES



Bombom Coração 11 ml

A: 0.66 in
B: 1.22 in
C: 1.06 in
oz: 0.37
Item No.: 019956

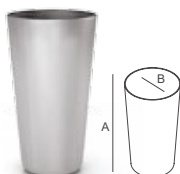

Lollita

A: 2.48 in
B: 1.38 in
oz: 1.5
Item No.: 002115

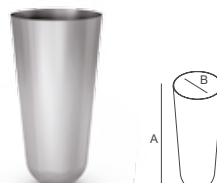

Lollita Arredondada

A: 2.67 in
B: 1.38 in
oz: 1.6
Item No.: 002114

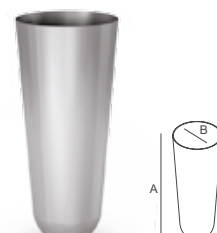

Lolly Arredondada

A: 3.71 in
B: 1.49 in
oz: 2.5
Item No.: 002113



Lolly

A: 3.53 in
B: 1.48 in
oz: 2.5
Item No.: 014257



Ituzinho

A: 4.52 in
B: 1.49 in
oz: 4
Item No.: 003067

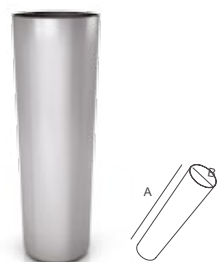

Mini-itu 60 ml

A: 3.91 in
B: 1.19 in
oz: 2
Item No.: 002112



Drill

A: 4.52 in
B: 1.49 in
oz: 3.2
Item No.: 001361



Tetra

A: 4.4 in
B: 1.49 in
oz: 3.2
Item No.: 010103



Minidrill

A: 4.52 in
B: 1.49 in
oz: 3.21
Item No.: 001417

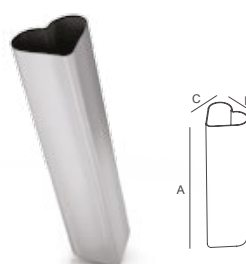

Coração

A: 3.93 in
B: 1.17 in
C: 1.03 in
oz: 1.6
Item No.: 012507



Banana 55 ml

A: 3.99 in
B: 1 in
C: 1.17 in
oz: 1.9
Item No.: 002111

We also have online and presential courses, recipe books and consulting. Check it out on our website: finamac.com

También tenemos cursos presenciales y online, libros de recetas y consultoría. Compruébalo en nuestro sitio web: finamac.com

MODELS WITH 18 CAVITIES

MODELOS CON 18 CAVIDADES

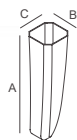

Banana 60 ml

A: 4.28 in
B: 1 in
C: 1.17 in
oz: 2
Item No.: 015815

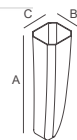

Banana 66 ml

A: 4.5 in
B: 1 in
C: 1.17 in
oz: 2.2
Item No.: 002110



Recife

A: 3.32 in
B: 1.49 in
oz: 2.9
Item No.: 002109



Frevo

A: 3.88 in
B: 1.68 in
oz: 1.5
Item No.: 016798

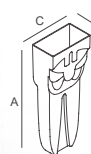

Coelho

A: 4.45 in
B: 1 in
C: 1.7 in
oz: 2.5
Item No.: 002108

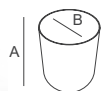

Bombom no Palito

A: 1.37 in
B: 1.18 in
oz: 0.74
Item No.: 007331



Hexagonal

A: 3.88 in
B: 1.38 in
oz: 2.8
Item No.: 018867

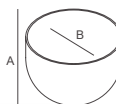

Bombom 23 ml

A: 1.03 in
B: 1.49 in
oz: 0.8
Item No.: 001323

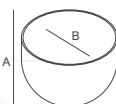

Bombom 11 ml

A: 0.88 in
B: 1.13 in
oz: 0.4
Item No.: 002097

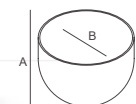

Bombom 17 ml

A: 0.97 in
B: 1.35 in
oz: 0.6
Item No.: 001250



Catarina Helicoidal

A: 7.87 in
B: 1.37 in
oz: 3.98
Item No.: 002098

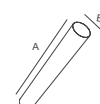

Catarina Lisa 80 ml

A: 5.09 in
B: 1.24 in
oz: 2.70
Item No.: 002106

We also have online and presential courses, recipe books and consulting. Check it out on our website: finamac.com

También tenemos cursos presenciales y online, libros de recetas y consultoría. Compruébalo en nuestro sitio web: finamac.com

MODELS WITH 18 CAVITIES

MODELOS CON 18 CAVIDADES



Catarina Lisa 140 ml

A: 7.84 in
B: 1.37 in
oz: 4.73
Item No.: 014260

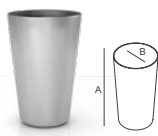

Lollitinha

A: 2.04 in
B: 1.37 in
oz: 1.28
Item No.: 002116



Recheio Dril

A: 3.55 in
B: 1.18 in
oz: 1.38
Item No.: 008232



Tetra 96 ml

A: 4.52 in
B: 1.49 in
oz: 3.24
Item No.: 010103

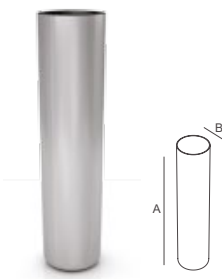

Tutti Colori 45 ml

A: 3.97 in
B: 0.97 in
oz: 1.52
Item No.: 007946

We also have online and presential courses, recipe books and consulting. Check it out on our website: finamac.com

También tenemos cursos presenciales y online, libros de recetas y consultoría. Compruébalo en nuestro sitio web: finamac.com

MODELS WITH 22 AND 28 CAVITIES

MODELOS CON 22 Y 28 CAVIDADES

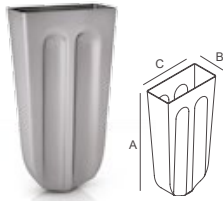

Baianinho

A: 3.26 in
B: 0.73 in
C: 1.7 in
oz: 1.5

Item No.: 013570 (22)
/ 018865 (28)



Brida 63 ml

A: 3.8 in
B: 0.74 in
C: 1.7 in
oz: 2.1

Item No.: 02539 (22)
/ 002248 (28)

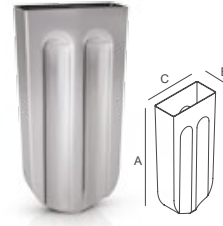

Brida 58 ml

A: 3.4 in
B: 0.74 in
C: 1.7 in
oz: 2

Item No.: 002187 (22)
/ 018864 (28)

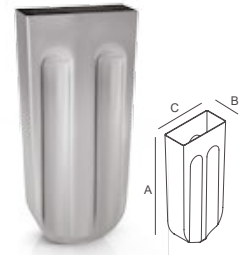

Brida Frut 68 ml

A: 3.8 in
B: 0.83 in
C: 1.7 in
oz: 2.3

Item No.: 008233 (22)
/ 008234 (28)

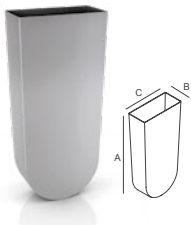

Megamaxi

A: 3.74 in
B: 0.90 in
C: 1.77 in
oz: 2.70

Item No.: 019953 (22)
/ 008905 (28)

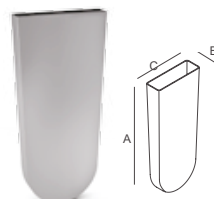

Recheio 22 ml

A: 3.13 in
B: 0.42 in
C: 1.34 in
oz: 0.7

Item No.: 010633 (22)
/ 018861 (28)

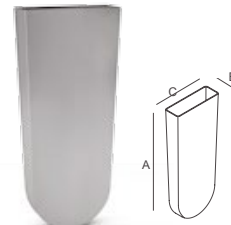

**Recheio 30 ml /
Mini-Picolé**

A: 3.57 in
B: 0.67 in
C: 1.36 in
oz: 1

Item No.: 002129 (22)
/ 001363 (28)

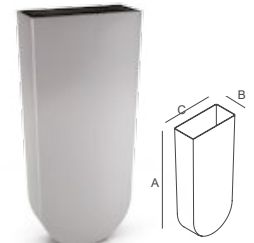

Brilis

A: 3.78 in
B: 0.75 in
C: 1.68 in
oz: 2.2

Item No.: 012047 (22)
/ 016597 (28)

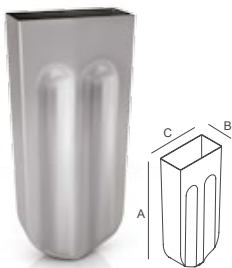

Megamid 80 ml

A: 3.99 in
B: 0.86 in
C: 1.76 in
oz: 2.7

Item No.: 013052 (22)
/ 012498 (28)

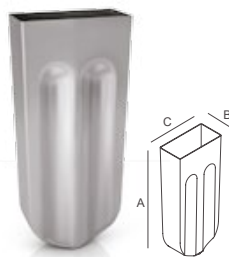

Megamid 72 ml

A: 3.73 in
B: 0.86 in
C: 1.76 in
oz: 2.4

Item No.: 008243 (22)
/ 002022 (28)

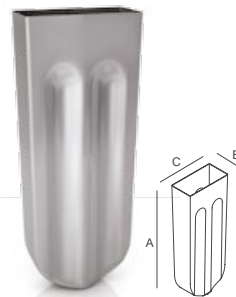

Megamex

A: 4.51 in
B: 0.86 in
C: 1.76 in
oz: 3

Item No.: 003215 (22)
/ 003216 (28)



Wave 63 ml

A: 3.82 in
B: 0.84 in
C: 1.68 in
oz: 2.1

Item No.: 018869 (22)
/ 018859 (28)

We also have online and presental courses, recipe books and consulting. Check it out on our website: finamac.com

También tenemos cursos presenciales y online, libros de recetas y consultoría. Compruébalo en nuestro sitio web: finamac.com

MODELS WITH 22 AND 28 CAVITIES

MODELOS CON 22 Y 28 CAVIDADES

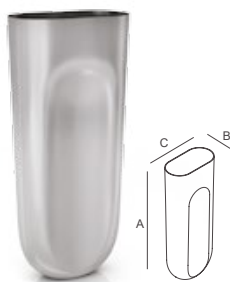

Wave 70 ml

A: 4.18 in
B: 0.84 in
C: 1.68 in
oz: 2.4

Item No.: 010657 (22)
/ 002765 (28)

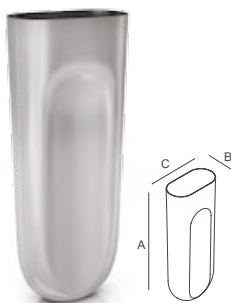

Wave 78 ml

A: 4.66 in
B: 0.84 in
C: 1.68 in
oz: 2.6

Item No.: 002151 (22)
/ 018860 (28)



Tutti Colore 45 ml

A: 4 in
B: 0.98 in
oz: 1.5

Item No.: 002150 (22)
/ 002024 (28)

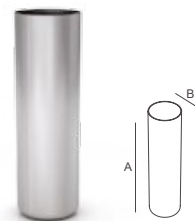

Tutti Colore 35 ml

A: 2.04 in
B: 0.98 in
oz: 1.2

Item No.: 001943 (22)
/ 018858 (28)

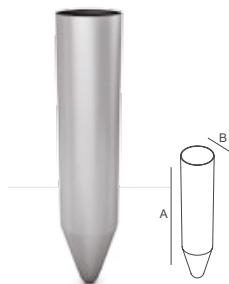

Lápis

A: 4.47 in
B: 0.98 in
oz: 1.5

Item No.: 002128 (22)
/ 018857 (28)

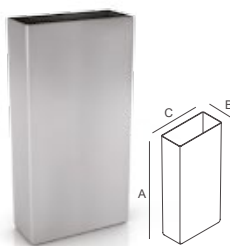

Skimo

A: 3.53 in
B: 0.98 in
C: 1.68 in
oz: 2.4

Item No.: 014701 (22)
/ 015817 (28)

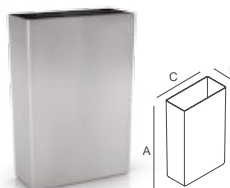

Skiminho

A: 2.52 in
B: 0.98 in
C: 1.68 in
oz: 1.7

Item No.: 002119 (22)
/ 018856 (28)

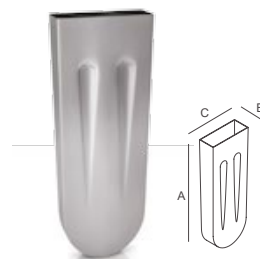

Brida Slim

A: 4.3 in
B: 0.58 in
C: 1.57 in
oz: 1.9

Item No.: 002118 (22)
/ 001680 (28)

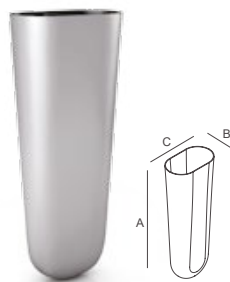

Soft

A: 4.22 in
B: 0.97 in
C: 1.68 in
oz: 2.4

Item No.: 018854
ONLY 28 CAVITIES
SÓLO 28 CAVIDADES

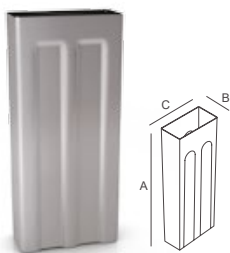

Freezy

A: 3.67 in
B: 0.75 in
C: 1.68 in
oz: 2.3

Item No.: 001670 (22)
/ 001362 (28)



Mini Brida 35 ml

A: 2.83 in
B: 0.67 in
C: 1.64 in
oz: 1.2

Item No.: 008237 (22)
/ 008238 (28)

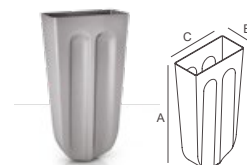

Mini Brida 30 ml

A: 2.54 in
B: 0.67 in
C: 1.64 in
oz: 1

Item No.: 008239 (22)
/ 008240 (28)

We also have online and presential courses, recipe books and consulting. Check it out on our website: finamac.com

También tenemos cursos presenciales y online, libros de recetas y consultoría. Compruébalo en nuestro sitio web: finamac.com

MODELS WITH 22 AND 28 CAVITIES

MODELOS CON 22 Y 28 CAVIDADES

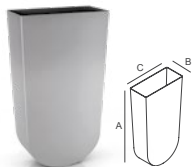

Mini-extrusado 48 ml

A: 2,81 in
B: 0,73 in
C: 1,64 in
oz: 1,62

Item No.: 019960
ONLY 22 CAVITIES
SÓLO 22 CAVIDADES

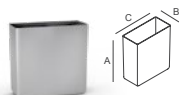

Bombom Quadrado

A: 1,73 in
B: 0,74 in
C: 1,71 in
oz: 1,18

Item No.: 002117 (22)
/ 018862 (28)

We also have online and presential courses, recipe books and consulting. Check it out on our website: finamac.com

También tenemos cursos presenciales y online, libros de recetas y consultoría. Compruébalo en nuestro sitio web: finamac.com

MODELS WITH 26 CAVITIES

MODELOS CON 26 CAVIDADES

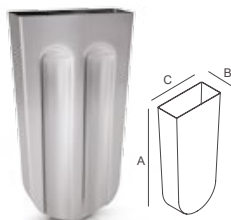

Maxibrida

A: 4.16 in
B: 0.9 in
C: 2.12 in
oz: 3.4
Item No.: 018866

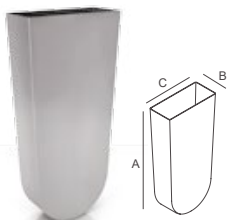

Maximid 108 ml

A: 4.16 in
B: 0.9 in
C: 2.12 in
oz: 3.7
Item No.: 013246

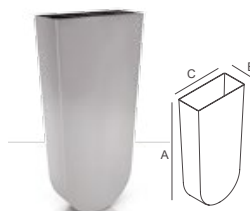

Maximid 100 ml

A: 3.91 in
B: 0.9 in
C: 2.12 in
oz: 3.4
Item No.: 002094

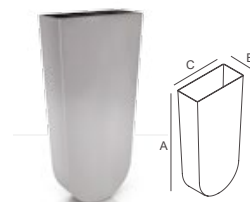

Maximid 95 ml

A: 3.76 in
B: 0.9 in
C: 2.12 in
oz: 3.2
Item No.: 002093

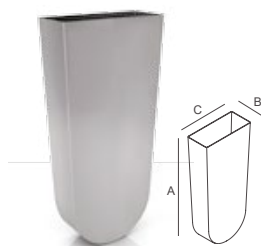

Maxim's

A: 4.51 in
B: 0.9 in
C: 2.12 in
oz: 4
Item No.: 013185

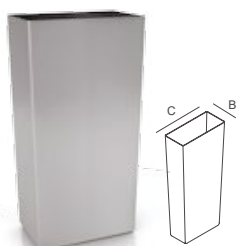

Mich

A: 4.51 in
B: 0.9 in
C: 2.12 in
oz: 4.2
Item No.: 012971

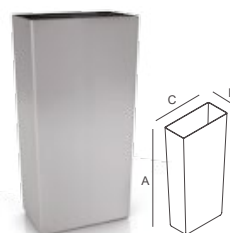

Michmid

A: 4.16 in
B: 0.9 in
C: 2.12 in
oz: 3.8
Item No.: 013426

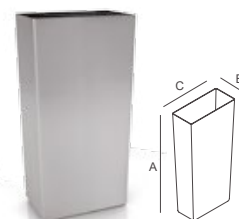

Michmid 100 ml

A: 3.7 in
B: 0.9 in
C: 2.12 in
oz: 3.4
Item No.: 002073

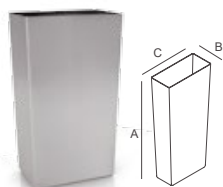

Mini Paleta

A: 3.38 in
B: 0.88 in
C: 2.08 in
oz: 3
Item No.: 001344

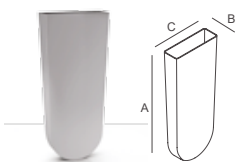

Recheio 28 ml

A: 2.75 in
B: 0.54 in
C: 1.32 in
oz: 0.9
Item No.: 001657

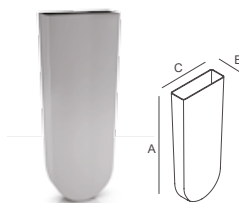

Recheio 35 ml

A: 3.53 in
B: 0.58 in
C: 1.34 in
oz: 1.2
Item No.: 002072

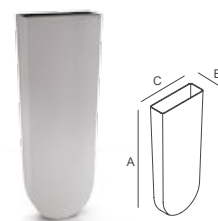

Recheio 39 ml

A: 3.61 in
B: 0.58 in
C: 1.35 in
oz: 1.3
Item No.: 017478

We also have online and presential courses, recipe books and consulting. Check it out on our website: finamac.com

También tenemos cursos presenciales y online, libros de recetas y consultoría. Compruébalo en nuestro sitio web: finamac.com

MODELS WITH 26 CAVITIES

MODELOS CON 26 CAVIDADES

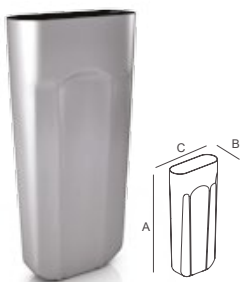

Carioca

A: 4.53 in
B: 0.83 in
C: 2.16 in
oz: 2.9
Item No.: 016799

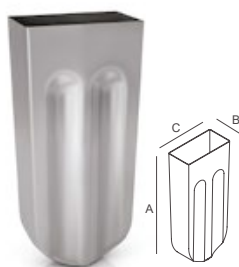

Megamid 87 ml

A: 3.99 in
B: 0.96 in
C: 1.7 in
oz: 2.9
Item No.: 002064

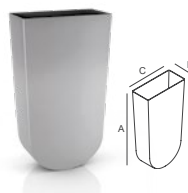

Mini-extrusado 48 ml

A: 2.81 in
B: 0.73 in
C: 1.64 in
oz: 1.62
Item No.: 019961

Models with 12 cavities

MODELOS CON 12 CAVIDADES



Monoporção

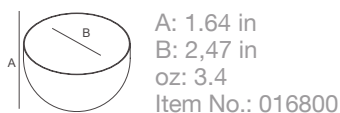

A: 1.64 in
B: 2.47 in
oz: 3.4
Item No.: 016800



Monoporção 150 ml

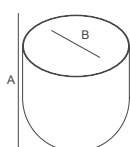

A: 2.26 in
B: 2.47 in
oz: 5.1
Item No.: 000089



Morezinha

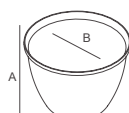

A: 1.89 in
B: 2.4 in
oz: 3.3
Item No.: 001251



Gelo Cubo 200 ml



A: 4.72 in
B: 1.67 in
C: 1.67 in
oz: 6.76
Item No.: 019962

MODELS WITH 36 CAVITIES

MODELOS CON 36 CAVIDADES



Bombom Quadrado 14 ml

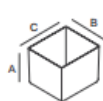

A: 0.90 in
B: 0.94 in
C: 0.94 in
oz: 0.49
Item No.: 019959

MODELS WITH 38 CAVITIES

MODELOS CON 38 CAVIDADES



Bombom Coração 11 ml



A: 0.66 in
B: 1.22 in
C: 1.06 in
oz: 0.37
Item No.: 008242



Bombom Coração 14 ml



A: 0.80 in
B: 1.22 in
C: 1.06 in
oz: 0.47
Item No.: 019957



Bombom Redondo

A: 0.88 in
B: 1.14 in
oz: 0.37
Item No.: 019958

For other models, consult Finamac or your local representative.
Para otros modelos, consulte a Finamac o a su representante local.

We also have online and presental courses, recipe books and consulting. Check it out on our website: finamac.com

También tenemos cursos presenciales y online, libros de recetas y consultoría. Compruébalo en nuestro sitio web: finamac.com

MODELS WITH 14 CAVITIES

MODELOS CON 14 CAVIDADES

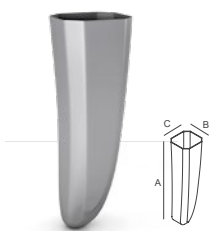

Banana 55 ml

A: 3.99 in
B: 1 in
C: 1.17 in
oz: 1.9
Item No.: 002225

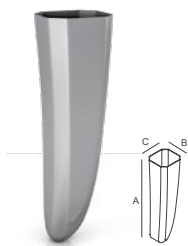

Banana 60 ml

A: 4.28 in
B: 1 in
C: 1.17 in
oz: 2
Item No.: 002223

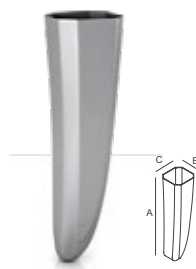

Banana 66 ml

A: 4.5 in
B: 1 in
C: 1.17 in
oz: 2.2
Item No.: 002222



Catarina Lisa 140 ml

A: 7.84 in
B: 1.37 in
oz: 4.73
Item No.: 002219



Bombom 11 ml

A: 0.88 in
B: 1.13 in
oz: 0.4
Item No.: 001547



Bombom 17 ml

A: 0.97 in
B: 1.35 in
oz: 0.6
Item No.: 002227



Bombom 23 ml

A: 1.03 in
B: 1.49 in
oz: 0.8
Item No.: 002226



Bombom Coração 11 ml

A: 0.66 in
B: 1.22 in
C: 1.06 in
oz: 0.37
Item No.: 019955



Catarina Helicoidal

A: 7.87 in
B: 1.37 in
oz: 3.98
Item No.: 002206



Catarina Lisa 80 ml

A: 5.09 in
B: 1.24 in
oz: 2.70
Item No.: 002220



Coração

A: 3.93 in
B: 1.17 in
C: 1.03 in
oz: 1.6
Item No.: 002233



Cubo Especial 220 ml

A: 1.41 in
B: 2.04 in
C: 4.76 in
D: 1.29 in
E: 1.92 in
oz: 7.43
Item No.: 019963

We also have online and presential courses, recipe books and consulting. Check it out on our website: finamac.com

También tenemos cursos presenciales y online, libros de recetas y consultoría. Compruébalo en nuestro sitio web: finamac.com

MODELS WITH 14 CAVITIES

MODELOS CON 14 CAVIDADES



Cubo Especial 110 ml

A: 1.36 in
B: 1.99 in
C: 2.50 in
D: 1.29 in
E: 1.92 in
oz: 3.71
Item No.: 030277



Drill

A: 4.52 in
B: 1.49 in
oz: 3.21
Item No.: 003068



Hexagonal

A: 3.88 in
B: 1.38 in
oz: 2.8
Item No.: 001847



Ituzinho

A: 4.52 in
B: 1.49 in
oz: 4
Item No.: 004179

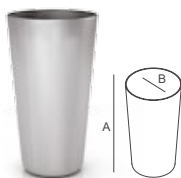

Lollita

A: 2.48 in
B: 1.38 in
oz: 1.5
Item No.: 014742

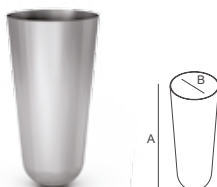

Lollita Arredondada

A: 2.67 in
B: 1.38 in
oz: 1.6
Item No.: 002230



Lollitinha

A: 2.05 in
B: 1.38 in
oz: 1.2
Item No.: 002231



Lolly Arredondada

A: 3.71 in
B: 1.49 in
oz: 2.5
Item No.: 002229



Tetra

A: 4.4 in
B: 1.49 in
oz: 3.2
Item No.: 002221



Minidrill

A: 3.95 in
B: 1.21 in
oz: 1.6
Item No.: 001848



Mini-itu 60 ml

A: 3.91 in
B: 1.19 in
oz: 2
Item No.: 001580



Recheio Dril

A: 3.55 in
B: 1.18 in
oz: 1.38
Item No.: 008231

We also have online and presential courses, recipe books and consulting. Check it out on our website: finamac.com

También tenemos cursos presenciales y online, libros de recetas y consultoría. Compruébalo en nuestro sitio web: finamac.com

MODELS WITH 14 CAVITIES

MODELOS CON 14 CAVIDADES

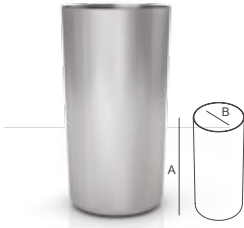

Recife

A: 3.32 in
B: 1.49 in
oz: 2.9

Item No.: 013416



Lolly

A: 3.53 in
B: 1.48 in
oz: 2.5

Item No.: 001305

MODELS WITH 10 CAVITIES

MODELOS CON 10 CAVIDADES



Cubo Especial 110 ml

A: 1.36 in
B: 1.99 in
C: 2.50 in
D: 1.29 in
E: 1.92 in
oz: 3.71

Item No.: 030276

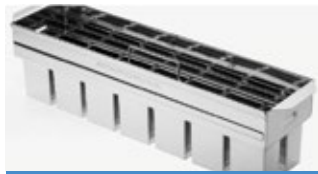

Cubo Especial 220 ml

A: 1.41 in
B: 2.04 in
C: 4.76 in
D: 1.29 in
E: 1.92 in
oz: 7.43

Item No.: 030275

MODELS WITH 16 CAVITIES

MODELOS CON 16 CAVIDADES



Cubo 70 ml



A: 1.71 in
B: 1.67 in
C: 1.67 in
oz: 2.36

N° Item: 009593



Gelo Cubo 200 ml

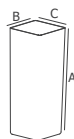

A: 4.72 in
B: 1.67 in
C: 1.67 in
oz: 6.76

Item No.: 009842

We also have online and presential courses, recipe books and consulting. Check it out on our website: finamac.com

También tenemos cursos presenciales y online, libros de recetas y consultoría. Compruébalo en nuestro sitio web: finamac.com

MOLD COMPATIBILITY CHART WITH MACHINES

CUADRO DE COMPATIBILIDAD DE MOLDES CON MÁQUINAS

	28 CAV	26 CAV	18 CAV
TURBO 8 	3	2	3
TURBO 25 	10	7	10
ROBOPOP START 	4	3	4
ROBOPOP ULTRA 	10	7	10
TURBO 80 	26	19	26
TURBO 100 	37	26	37
POPLINE 	30	23	30
POPCIRCLE 	32		32

We also have online and presential courses, recipe books and consulting. Check it out on our website: finamac.com

También tenemos cursos presenciales y online, libros de recetas y consultoría. Compruébalo en nuestro sitio web: finamac.com

STICK EXTRACTORS

EXTRACTORES PARA PALILLOS



STICK EXTRACTORS

- 12 holes for Moreninha (Item No. 002195)
- 14 holes for plane stick (Item No. 004180)
- 18 holes (Item No. 014258)
- 22 holes for plane stick / universal (Item No. 002540)
- 26 holes universal (Item No. 014980)
- 28 holes universal (Item No. 002249)
- 14 holes for round stick (Item No. 014743)
- 18 holes for round stick (Item No. 016802)
- 26 holes for plane stick (Item No. 009730)
- 26 holes for bowtie stick (Item No. 015771)
- 22 holes for round stick (Item No. 007950)
- 28 holes for round stick (Item No. 007952)
- 26 holes universal special (Item No. 030529)

EXTRACTORES PARA PALILLOS

- 12 agujeros para Moreninha (Item No. 002195)
- 14 agujeros para palillo plano (Item No. 004180)
- 18 agujeros (Item No. 014258)
- 22 agujeros para palillo plano / universal (Item No. 002540)
- 26 agujeros universal (Item No. 014980)
- 28 agujeros universal (Item No. 002249)
- 14 agujeros para palillo redondo (Item No. 014743)
- 18 agujeros para palillo redondo (Item No. 016802)
- 26 agujeros para palillo plano (Item No. 009730)
- 26 agujeros para palillo hélice (Item No. 015771)
- 22 agujeros para palillo redondo (Item No. 007950)
- 28 agujeros para palillo redondo (Item No. 007952)
- 26 agujeros universal especial (Item No. 030529)

STICKLESS HOLDERS (NEEDLES)

EXTRACTORES CON ALFILERES

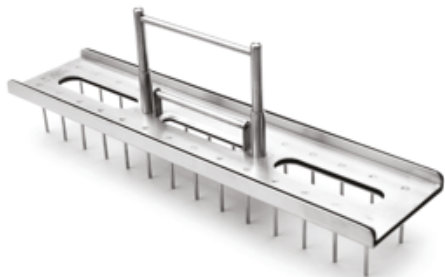

STICKLESS HOLDERS

- 18 needles (Item No. 015816)
- 36 needles (Item No. 007160)
- 14 needles (Item No. 001548)
- 12 needles (Item No. 016801)
- 22 needles (Item No. 007953)
- 28 needles (Item No. 007954)
- 26 needles (Item No. 009319)
- 38 needles (Item No. 007161)
- 12 needles (Cube) (Item No. 030255)
- 14 needles (Cube) (Item No. 030256)
- 16 needles (Item No. 009468)

EXTRACTORES CON ALFILERES

- 18 agujas (Item No. 015816)
- 36 agujas (Item No. 007160)
- 14 agujas (Item No. 001548)
- 12 agujas (Item No. 016801)
- 22 agujas (Item No. 007953)
- 28 agujas (Item No. 007954)
- 26 agujas (Item No. 009319)
- 38 agujas (Item No. 007161)
- 12 agujas (Cubo) (Item No. 030255)
- 14 agujas (Cubo) (Item No. 030256)
- 16 agujas (Item No. 009468)

*For other models, consult Finamac or your local representative.
Para otros modelos, consulte a Finamac o a su representante local.*

We also have online and presential courses, recipe books and consulting. Check it out on our website: finamac.com

También tenemos cursos presenciales y online, libros de recetas y consultoría. Compruébalo en nuestro sitio web: finamac.com

STICKS ALIGNER

ALINEADOR PALILLO



STICKS ALIGNER PLAIN
ALINEADOR PALILLO PLANO



STICKS ALIGNER HELIX
ALINEADOR PALILLO HÉLICE

- 28 tubes (Item No. 014744)
- 36 tubes (Item No. 003070)
- 44 tubes (Item No. 002541)
- 52 tubes universal (Item No. 015723)
- 56 tubes (Item No. 002250)
- 36 tubes special for bombom (Item No. 014259)
- 28 tubes universal (Item No. 030257)
- 36 tubes universal (Item No. 030258)
- 44 tubes universal (Item No. 030259)
- 52 tubes universal special (Item No. 030429)
- 56 tubos universal (Item No. 030260)
- Support for Moreninha (Item No. 007958)
- Simple Aligner 22 tubes (Item No. 030261)
- Simple Aligner 28 tubes (Item No. 030262)

- 28 tubos (Nº Item 014744)
- 36 tubos (Nº Item 003070)
- 44 tubos (Nº Item 002541)
- 52 tubos universal (Nº Item 015723)
- 56 tubos (Nº Item 002250)
- 36 tubos especial para bombom (Nº Item 014259)
- 28 tubos universal (Nº Item 030257)
- 36 tubos universal (Nº Item 030258)
- 44 tubos universal (Nº Item 030259)
- 52 tubos universal especial (Nº Item 030429)
- 56 tubos universal (Nº Item 030260)
- suporte p/ moreninha (Nº Item 007958)
- Alinhador simples 22 tubos (Nº Item 030261)
- Alinhador simples 28 tubos (Nº Item 030262)

*For other models, consult Finamac or your local representative.
Para otros modelos, consulte a Finamac o a su representante local.*

We also have online and presential courses, recipe books and consulting. Check it out on our website: finamac.com

También tenemos cursos presenciales y online, libros de recetas y consultoría. Compruébalo en nuestro sitio web: finamac.com

STICKS

PALILLOS

Material: Birch wood / Madera de abedul



Narrow

Común
4.5 in x 0.4 in (114 mm x 10 mm)
Package of 10000 units
Paquete de 10.000 unidades
Item No.: 120000



Bow Tie

Hélice
3.6 in x 0.6 in (93mm x 17mm)
Package of 10000 units
Paquete de 10.000 unidades
Item No.: 120002



Round Stick

Palillo Redondo
Package of 10000 units
Package of 10000 units
Paquete de 10.000 unidades
Item No.: 120008



Narrow Customized*

Común Personalizado
4.5 in x 0.4 in (114 mm x 10 mm)
Package of 10000 units
Paquete de 10.000 unidades
Item No.: 120001



Bow Tie Customized*

Hélice Personalizado
3.6 in x 0.6 in (93mm x 17mm)
Package of 10000 units
Paquete de 10.000 unidades
Item No.: 120003

*Tool to customize Item No.: 120004 / *Herramienta para personalizar Item No.: 120004

STICKS COLORS

COLORES DE PALILLOS

Apricot 163		Green 348		Orange 1495	
Aqua 317		Green 350		Lime 389	
Black		Green 354		Papaya 488	
Blue 286U		Green 357		Pink 214	
Blue 3125		Green 389C		Pink 1775	
Blue 5483		Lemon 587		Pink 7422	
Brown 168		Marigold1235		Magneta	
Brown 4625		Mango 150		Red 703	
Canary 129		Mint 338c		Red 1805	
Cool Gray 5		Navy 647		Sea Breeze 628	
Curry 117		Orange 021		Violet C	
Curry 125C		Orange 165		Yellow C	
Green 339		Orange 172		Yellow 1215	

We also have online and presential courses, recipe books and consulting. Check it out on our website: finamac.com

También tenemos cursos presenciales y online, libros de recetas y consultoría. Compruébalo en nuestro sitio web: finamac.com



Standard (Clear)

Patrón (Transparente)
2.9 in x 8 in (75 mm x 205 mm)
Thickness: 42 microns
Espesor: 42 micras
Material: PET/PE
Minimum order: 10000
Pedido mínimo: 10000
Item No.: 110201



Paleta (Clear)

Paleta (Transparente)
3.3 in x 8 in (85 mm x 205 mm)
Thickness: 42 microns
Espesor: 42 micras
Material: PET/PE
Minimum order: 10000
Pedido mínimo: 10000
Item No.: 110200

ROLLSTOCK PACKAGING

EMPAQUETADO DE ROLLOS

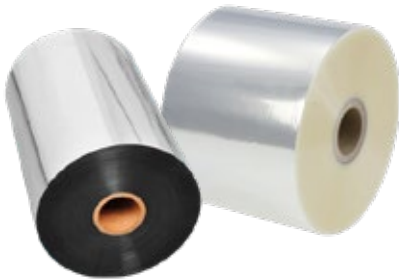

- **200mm BOPP/PE Clear Roll (Item No. 110300)**
(200 mm wide, 76 mm inner diameter 300 mm outer diameter)
(200 mm de ancho, 76 mm de diámetro interior y 300 mm de diámetro exterior)
- **160mm BOPP/PE Clear Roll (Item No. 110301)**
(160 mm wide, 76 mm inner diameter 300 mm outer diameter)
(160 mm de ancho, 76 mm de diámetro interior y 300 mm de diámetro exterior)
- **200mm VMPET Metallized Roll (Item No. 110305)**
(200 mm wide, 76 mm inner diameter 300 mm outer diameter)
(200 mm de ancho, 76 mm de diámetro interior y 300 mm de diámetro exterior)
- **160mm VMPET Metallized Roll (Item No. 110306)**
(160 mm wide, 76 mm inner diameter 300 mm outer diameter)
(160 mm de ancho, 76 mm de diámetro interior y 300 mm de diámetro exterior)

* These rolls are only compatible with automatic wrapping machines.
* Estos rollos sólo son compatibles con las máquinas empaquetadoras automáticas.

We also have online and presential courses, recipe books and consulting. Check it out on our website: finamac.com

También tenemos cursos presenciales y online, libros de recetas y consultoría. Compruébalo en nuestro sitio web: finamac.com

FREEZING FLUIDS

LÍQUIDOS DE CONGELACIÓN



FinaFluid Pail

Pail with 5 gallons
Balde con 5 galones
Item No. 100226
FinaPowder No. 18241



Glycol Pail

Pail with 5 gallons
Balde con 5 galones
Item No. 100189



Paratherm Pail

Pail with 5 gallons
Balde con 5 galones
Item No. 100259



FinaFluid Drum

Drum with 55 gallons
Barril con 55 galones
Item No. 100294



Glycol Drum

Drum with 55 gallons
Barril con 55 galones
Item No. 100162



FinaFluid Tote

Tote with 275 gallons
Barril con 275 galones
Item No. 100276



Glycol Tote

Tote with 275 gallons
Granel con 275 galones
Item No. 100205

FLUID MEASURING TOOLS

HERRAMIENTAS DE MEDICIÓN DE FLUIDOS



Refractometer

Refractómetro
(For Glycol)
(Para el Glicol)
Item No. 100109
From Brazil Item No. 007836



Densimeter











Densímetro
(For FinaFluid)
(Para el FinaFluid)
Item No. 100218
From Brazil Item No. 009221

We also have online and presential courses, recipe books and consulting. Check it out on our website: finamac.com

También tenemos cursos presenciales y online, libros de recetas y consultoría. Compruébalo en nuestro sitio web: finamac.com

FLUIDS COMPATIBILITY CHART WITH MACHINES

CUADRO DE COMPATIBILIDAD DE FLUIDOS CON MÁQUINAS

	ETHANOL*	PROPYLENE GLYCOL**	FINAFLUID (NON FLAMMABLE)
TURBO 8 			
TURBO 25 			
ROBOPOP START 			
ROBOPOP ULTRA 			
TURBO 80 		 ***	
TURBO 100 		 ***	
POPLINE 		 ***	
POPCIRCLE 		 ***	

* Consult your local legislation. In some countries the use of alcohol is prohibited.

** Production reduced by 30% when using glycol.

*** The industrial line needs to be adapted when using glycol. It must be indicated in the order.

* Consulte su legislación local. En algunos países está prohibido el uso de alcohol.

** Producción reducida en un 30% cuando se usa glicol.

*** La línea industrial necesita ser adaptada cuando se usa glicol. Debe estar indicado en el pedido.

We also have online and presential courses, recipe books and consulting. Check it out on our website: finamac.com

También tenemos cursos presenciales y online, libros de recetas y consultoría. Compruébalo en nuestro sitio web: finamac.com

RECIPE BOOKS

RECETARIOS



Module: Pets



Artisanal Ice Cream & Ice Pops Bundle
Recetario Completo de Paletas y Helados Artesanales



Module Alcoholics
Módulo Alcohólicas



Module Alcoholics 2



Module Acai
Módulo Acai



Module Lactoso Free, Fruits
Módulo Sin Lactosa, Frutas



Module Milk Bases
Módulo Base Leche



Module Special Collection
Módulo: Colección Especial



Module Exotic Flavors
Módulo de Sabores Exóticos



Module Vegan
Módulo Vegano

We also have online and presential courses, recipe books and consulting. Check it out on our website: finamac.com

También tenemos cursos presenciales y online, libros de recetas y consultoría. Compruébalo en nuestro sitio web: finamac.com

COURSES, TRAINING AND CONSULTING

CURSOS, ENTRENAMIENTO Y CONSULTORIAS

PRESENTIAL COURSES:

- Complete Ice Pop and Ice Cream Course;
- Complete Artisanal Ice Pop Course;
- Complete Artisanal Ice Cream Course;
- Gelato and Sorbetto Course;
- Ice Pop Demonstration.

ONLINE COURSES:

- Online Ice Pop and Ice Cream Making;
- Gelato Practical Online Course;
- Online Course of Ice Pops and Paletas Production;
- Balancing Recipe Online Course;
- 6 Advanced Ice Pop Modules.

CONSULTING:

- Improve your recipe;
- New flavors and recipes development consulting;
- Nutritional charts elaboration.

CURSOS PRESENCIALES:

- Curso Completo de Paletas y Helados;
- Curso Completo de Paletas Artesanales;
- Curso Completo de Helados Artesanales;
- Curso de Gelato y Sorbetto;
- Demostración de Paleta.

CURSOS ONLINE:

- Curso Online de Helados y Paletas;
- Curso Online Práctico de Gelato;
- Curso Online de producción de las Paletas y Paletas Mexicanas;
- Curso Online de Balanceo de Recetas;
- 6 Módulos Avanzados de Paletas.

CONSULTORÍA:

- Mejora tu receta;
- Consultoría para el desarrollo de nuevos sabores y recetas;
- Preparación de la tabla nutricional.

Check it out on our website: finamac.com/en/courses/

Compruébalo en nuestro sitio web: finamac.com/es/cursos/





FINAMAC.COM

+1-877-342-7458 | +1-786-408-0729

11231 NW 20TH STREET UNIT 130 MIAMI, FL 33172

 facebook.com/FinamacGlobal

 [@finamacglobal](https://instagram.com/finamacglobal)

 youtube.com/FinamacEnglish